

Taymor

PRODUCT SPECIFICATIONS

THE PREMIER LINE

WELLS LEVERSET

SPECIFICATIONS

- UNIVERSAL 6-IN-1 LATCH: DRIVE IN, SQUARE MORTISE AND RADIUS CORNER WITH ADJUSTABLE BACKSET: 2-3/8" (60 mm) – 2-3/4" (70 mm)
- STANDARD BORE HOLES: 2-1/8" (54 mm)
- FITS STANDARD DOOR THICKNESS: 1-3/8" (35 mm) – 1-3/4" (45 mm)
- FULL LIP RADIUS CORNER STRIKE WITH ADJUSTABLE TAB STANDARD: 1-3/4" x 2-1/4" (45 mm x 57 mm)



GRADE 3
ANSI GRADE 3

LIMITED LIFETIME MECHANICAL & FINISH WARRANTY

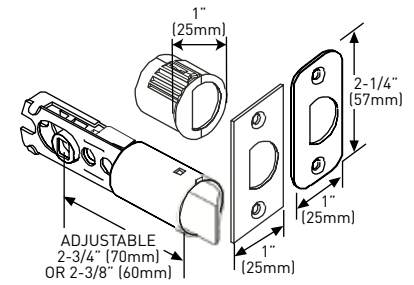
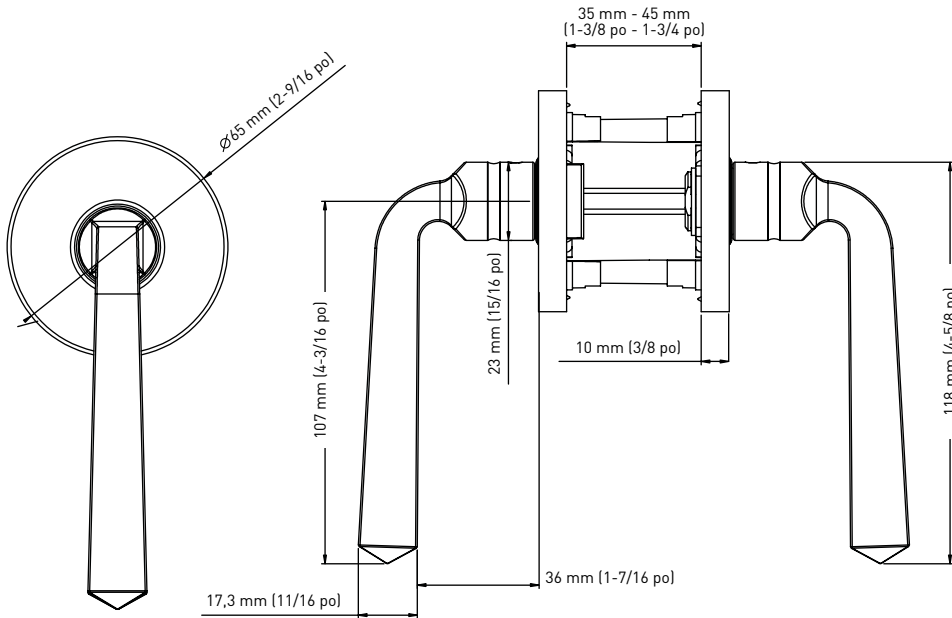
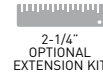

6-IN-1 PRIVACY/PASSAGE LATCH

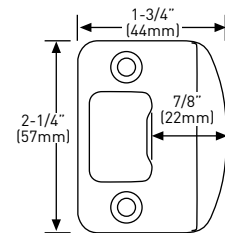

FULL LIP RADIUS STRIKE

BUILDER PACK	AGED BRONZE 10B+	SATIN NICKEL 15	POLISHED CHROME 26	CASE QTY.
Privacy	30-D006524BRN	30-D006524SN	30-D006524PC	20
Passage	30-D006534BRN	30-D006534SN	30-D006534PC	20
Inside Trim	30-HL0065BRN	30-HL0065SN	30-HL0065PC	20
Dummy	30-654BRN	30-654SN	30-654PC	20

SQUARE ROSE KIT OPTION



SQUARE CONTEMPORARY ROSE KIT

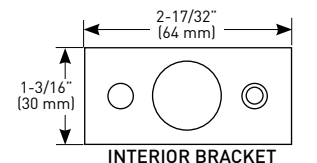
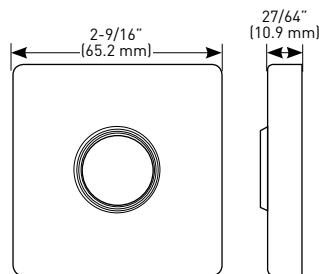

INTERIOR BRACKET

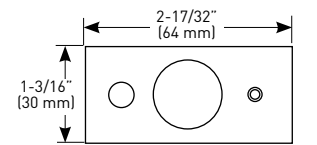

EXTERIOR BRACKET

BUILDER PACK	AGED BRONZE 10B+	SATIN NICKEL 15	MATTE BLACK 19	POLISHED CHROME 26	SATIN CHROME 26D	CASE QTY
Privacy	30-SQR0024BRN	30-SQR0024SN	30-SQR0024BLK	30-SQR0024PC	30-SQR0024SC	10
Passage	30-SQR0034BRN	30-SQR0034SN	30-SQR0034BLK	30-SQR0034PC	30-SQR0024SC	10
Dummy/Inside trim	30-SQR0044BRN	30-SQR0044SN	30-SQR0044BLK	30-SQR0044PC	30-SQR0024SC	10

MEASUREMENTS SUBJECT TO A 3% VARIANCE

MEASUREMENTS ARE FOR REFERENCE ONLY. TAYMOR RESERVES THE RIGHT TO CHANGE THE PRODUCT SPECS WITHOUT NOTICE. FOR PRODUCT WARRANTY, PLEASE VISIT TAYMOR WEBSITE FOR DETAILS

